



The worldwide **Conveyors** of automated garment sorting, storage & retrieval.

24 Hour Automated Dry Cleaner

Unattended Drop-Off and Pick-Up



The worldwide leader in
garment sorting technology for
dry cleaners

White Conveyor's 24 Hour
Automated Dry Cleaner (ADC)
provides your customers
round-the-clock service.
Reduce costs and increase
profits by replacing attended
drop stores or expanding
service to new locations.

Reduce Costs and Increase Profits While Providing Your Customers Unsurpassed Convenience



White Conveyor's Automated Dry Cleaner gives you the opportunity to expand your business without adding additional employees. New customers will love the convenience of round-the-clock service at train stations, corporate campuses, office building, apartment complexes – just about anywhere!

White's 24 Hour Automated Dry Cleaner (ADC) dramatically increases your profits while reducing costs by replacing attended drop stores or adding new locations. Expand your customer base by placing an unattended ADC at a train station, office building, corporate campus, or apartment complex. The possibilities are endless, and so are the potential profits when you put the ADC to work for you.

The ADC provides fast return on investment. You can expect 100% ROI in just 2 years. Just sit back and collect remarkable profits for many years with the ADC.

What's more, your customers will love the round-the-clock convenient service. They can drop off and pick up garments any time, day or night, on their way to work or play. There is no better way to build loyalty and new business. Major credit cards are accepted for on-site enrollment, making the system easy to use. Garments are delivered fast - the conveyor delivers multiple groupings in one cycle.

White's ADC is the perfect solution to expand your existing business, improve customer service and increase profits. Call or visit our website at www.white-conveyors.com today to learn more about the 24 hour ADC.

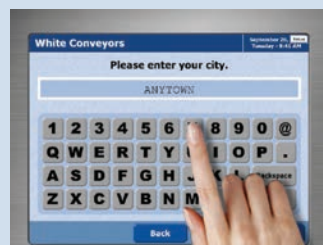

Easy-to-use touch screen buttons and keypad.

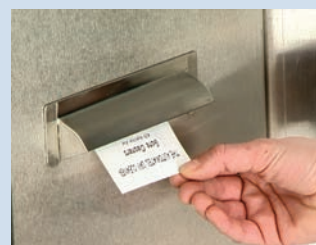

Printed receipts for all drop-off and pick-ups.



System delivers multiple groupings in one cycle to the secure door.

Reduce Costs and Increase Profits While Providing Your Customers Unsurpassed Convenience

ADC Customer Interface

- Security Camera
- Touchscreen Control
- Credit Card Receiver
- Access Door
- Receipt Printer
- Clothing Drop



ADC Features

- Unattended drop off and pick up of dry cleaning and laundry with fast return on investment.
- Offers a Competitive Advantage due to greater Customer Service.
- Credit card can be used for on-site enrollment.
- Fast delivery time – conveyor delivers multiple groupings in one cycle.
- ADC is interfaced with your point of sale (POS) program.
- Weather resistant – ideal for indoor or outdoor applications.
- Can be configured to fit your existing building – can go up, down and around corners.
- Expandable as your business or your needs grow – thanks to all modular construction.
- Sturdy construction with long lasting, durable components for many years of reliable use.
- American made with prompt support by White Conveyors, Inc. or authorized distributors.

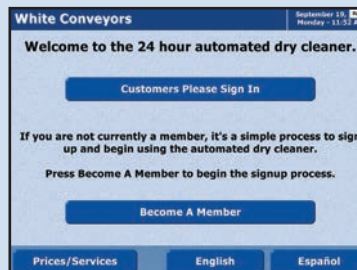

Welcome screen allows new customer registration or existing customer sign in.



During initial registration, customer swipes credit card once for all future payments.



Subsequent orders only require the customer's to enter their ten digit phone number and PIN.

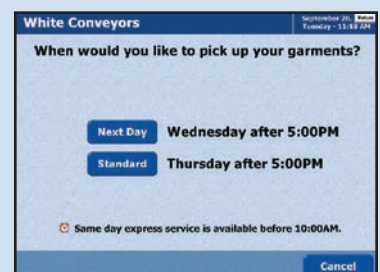

Customers can select from your pre-specified garment pick-up options.

24 Hour Automated Dry Cleaner (ADC)

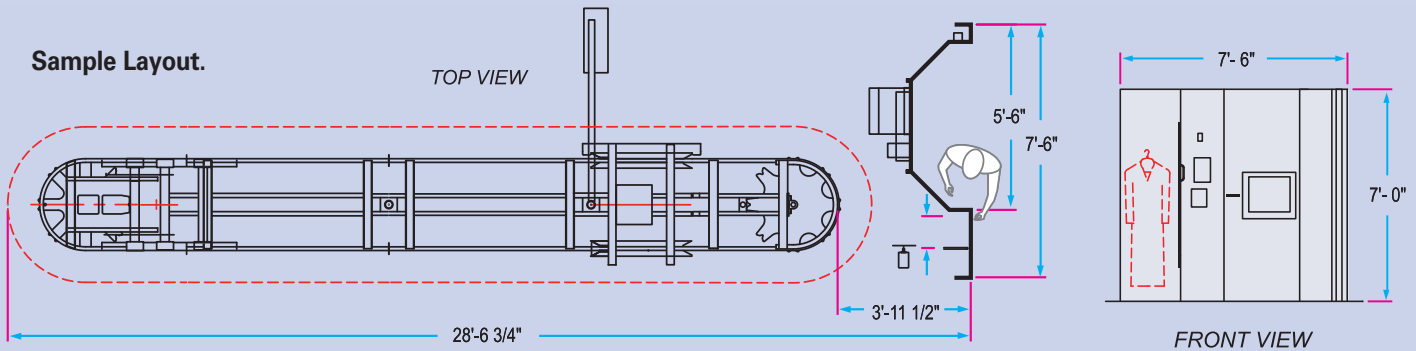

TYPICAL MODULAR SECTION SHAPES

White Conveyors are available in a wide variety of special shapes. You can "design your own conveyor" to fit most any length or shape by using our standard "modular" sections. Here are some typical shapes.

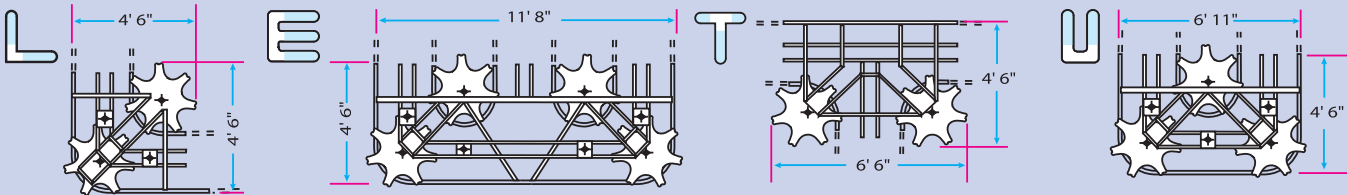

ADC Specifications

- 12 gauge stainless steel 304 front enclosure with #4 finish for outdoor or indoor use.
- .25" bronzed Lexan door with heavy duty actuator.
- Conveyor can be equipped with a mixture of 3 and 5 latch frames, aluminum chain and heavy duty 1hp inverter drive.
- Maximum garment access time is 27 seconds, conveyor speed is 90 ft./min.
- 15" color touch screen monitor/user interface.
- Card swipe with serial port communication.
- Thermal printer with 1500 ft. roll for less service, anti-jamming feature ensures that the receipt is presented only after it has been cut, preventing user from pulling receipt while still printing. Retrieves receipts after 15 seconds if not taken. Temps range 5°C to 40°C, no toner or ribbon to replace.
- Garment transfer drive with heavy duty motor.
- 20 AMP Quad dedicated ground (computer) circuit.
- 120V Quad outlet power feed to conveyor control box.
- 120V, 20 AMPS dedicated power feed to conveyor low voltage control box.
- Dedicated phone line.

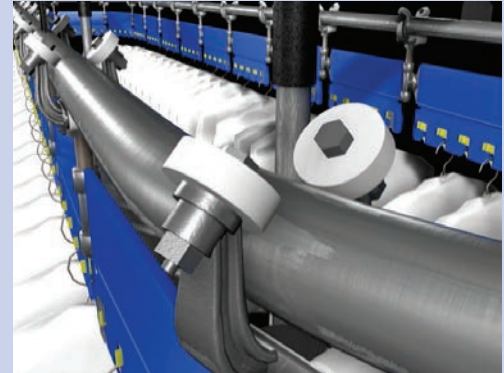

White Conveyors, Inc.

10 Boright Avenue, Kenilworth, NJ 07033 • 800-524-0273 • Int. 908-686-5700
www.White-Conveyors.com